



**PV SYSTEMS**  
**Agriphotovoltaics**

# Agriphotovoltaics

## Combining farming and solar generation

- Dual use of land
- Controlled environment for higher crop yield
- Reduced temperature for PV higher yield
- Decreased water usage

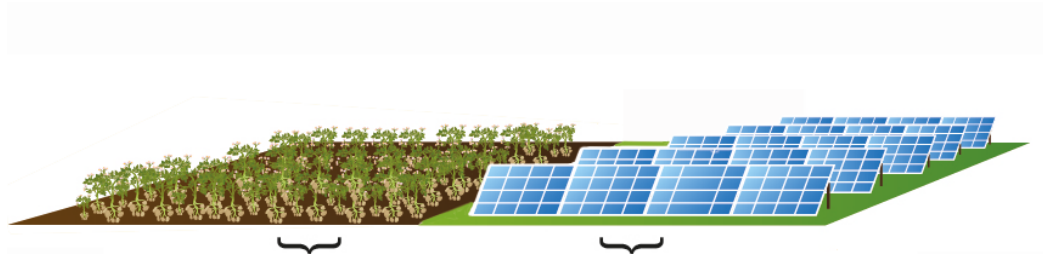

100% Kartoffeln und 100% Solarstrom

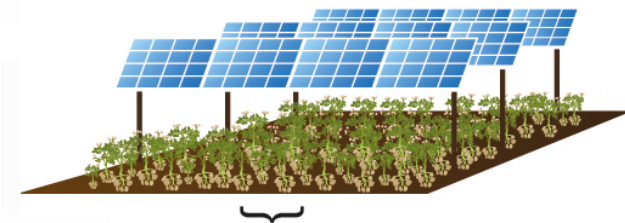

103% Kartoffeln >  
83% Solarstrom

186% Landnutzungseffizienz

# Agriphotovoltaics

## Combining farming and solar generation

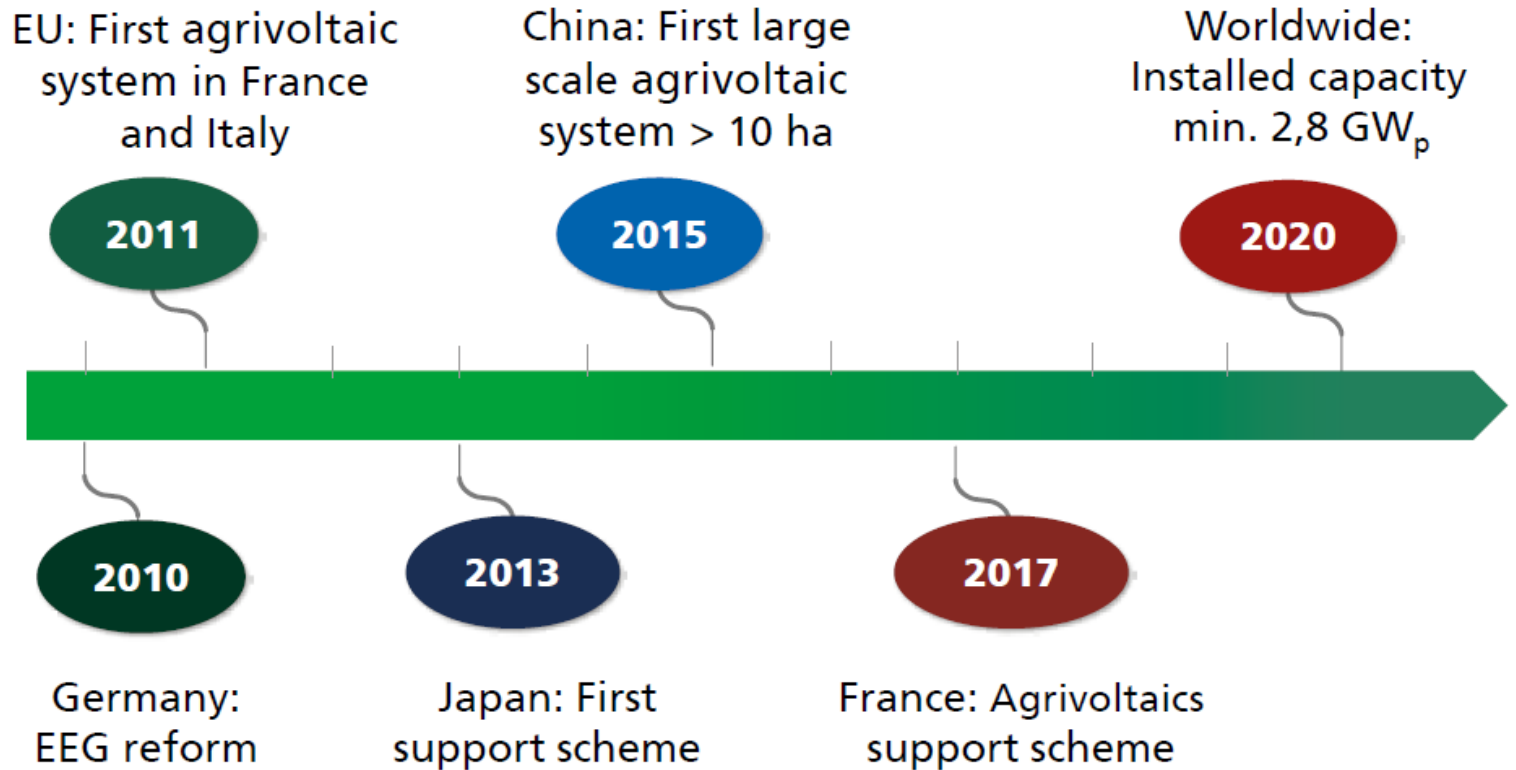

# Agriphotovoltaics

For standard ground mounted PV power plants:

- **Pollinator-friendly** planting, including under the panels.
- **Grazing sheep** reduces mowing, a normal maintenance requirement on solar installations
- **Horticulture**, requires raising PV modules, ok for PV tracking systems
- Growing **mushrooms** (40 tons/4MW in Japan)

# Agriphotovoltaics

## Combining farming and solar generation

#	Categories	Examples
I	Cropland (annual, perennial and permanent crops)	Orchards, berries, grapevines, vegetables and other types of arable farming
II	Grassland (permanent grassland)	Pastures and hayfields
III	Greenhouses (plants growing in closed systems)	Greenhouses and plastic tunnel

# Agriphotovoltaics

## Potential (PT)

Assuming 3 ha/MW (Technical Report NREL/TP-6A20-56290)

x5 to accommodate crops: 10 GW >>  $1.5 \times 10^5$  ha

Type of land	Million ha	% PV
Arable land	1.04	683%
Family garden	0.02	11%
Permanent crops	0.86	567%
Permanent pastures	2.05	1351%

PORDATA 2020



# Agriphotovoltaics



Ground mounted PV modules with the area between the panels being used for farming.

The spacing between the PV modules has been kept wide enough to allow standard sized farming equipment to pass between the rows.

# Agriphotovoltaics

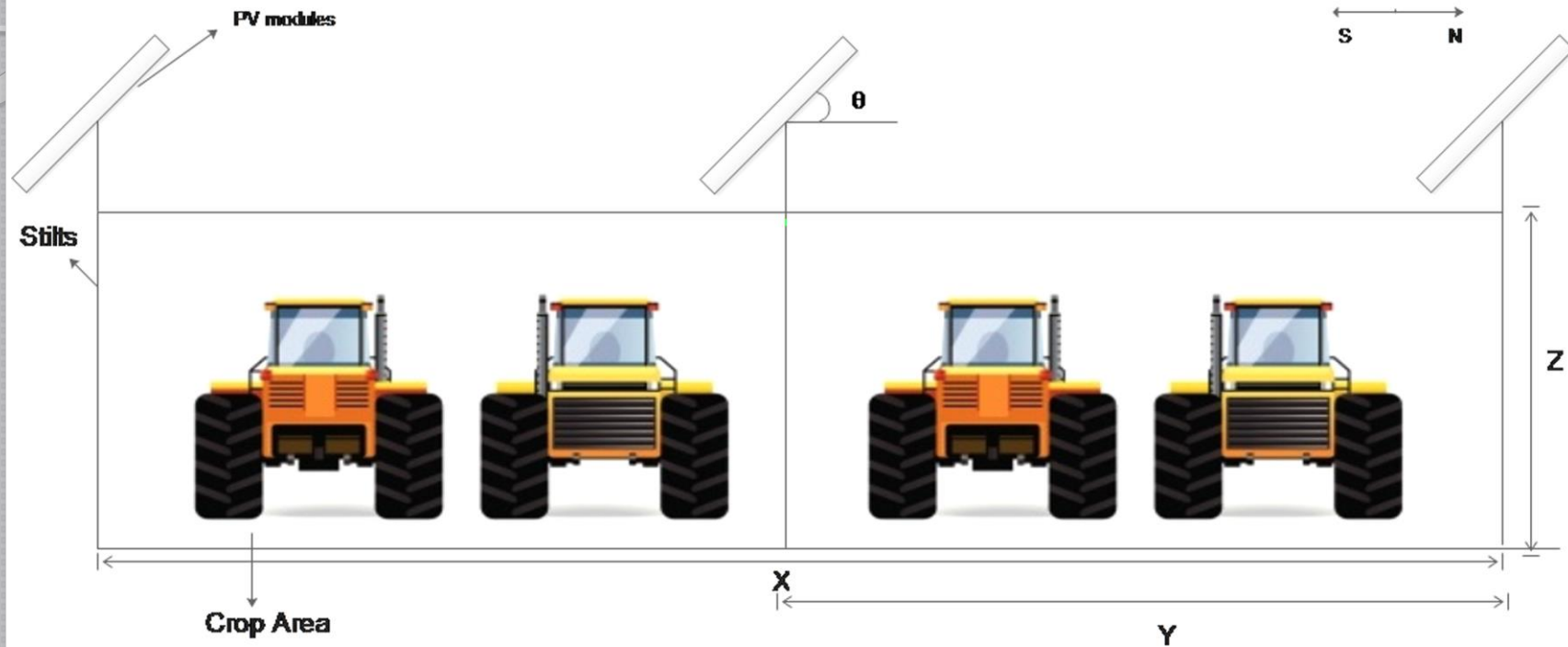

PV modules mounted on stilts.  
More expensive (racking) but better land use.



# Agriphotovoltaics

Higher costs than standard ground-mounted PV

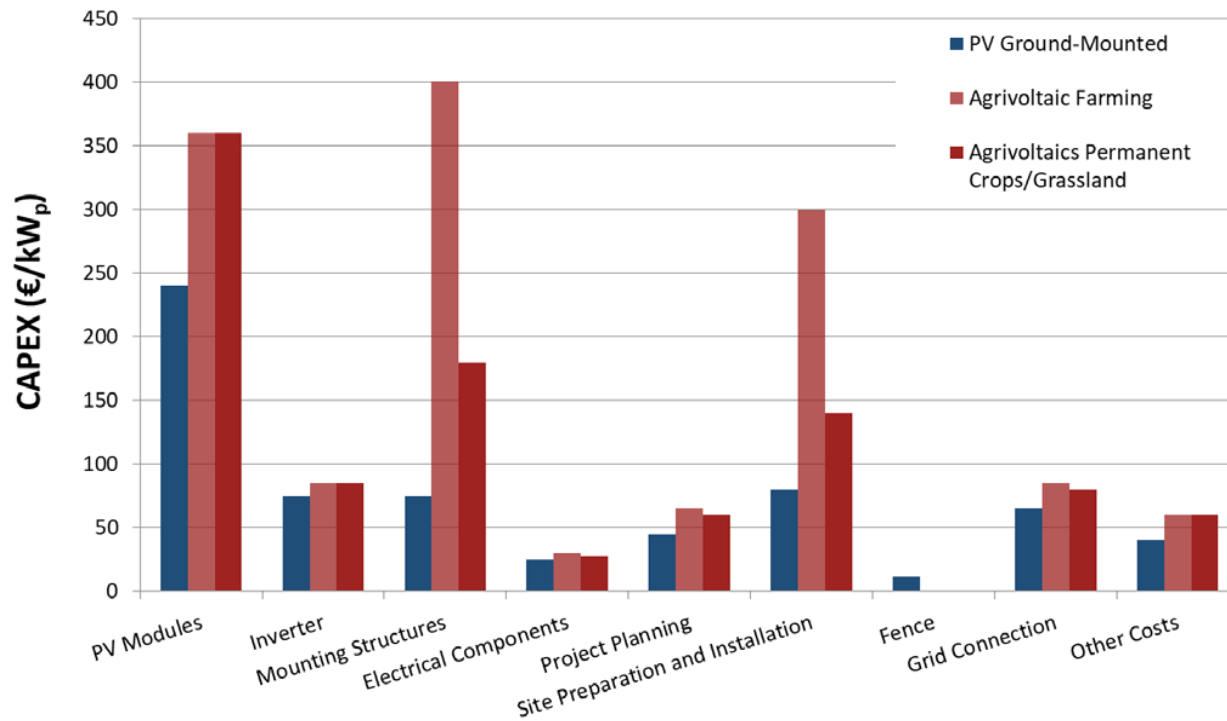

# Agriphotovoltaics

Higher costs than standard ground-mounted PV  
*(but cheaper than a roof-mounted PV)*

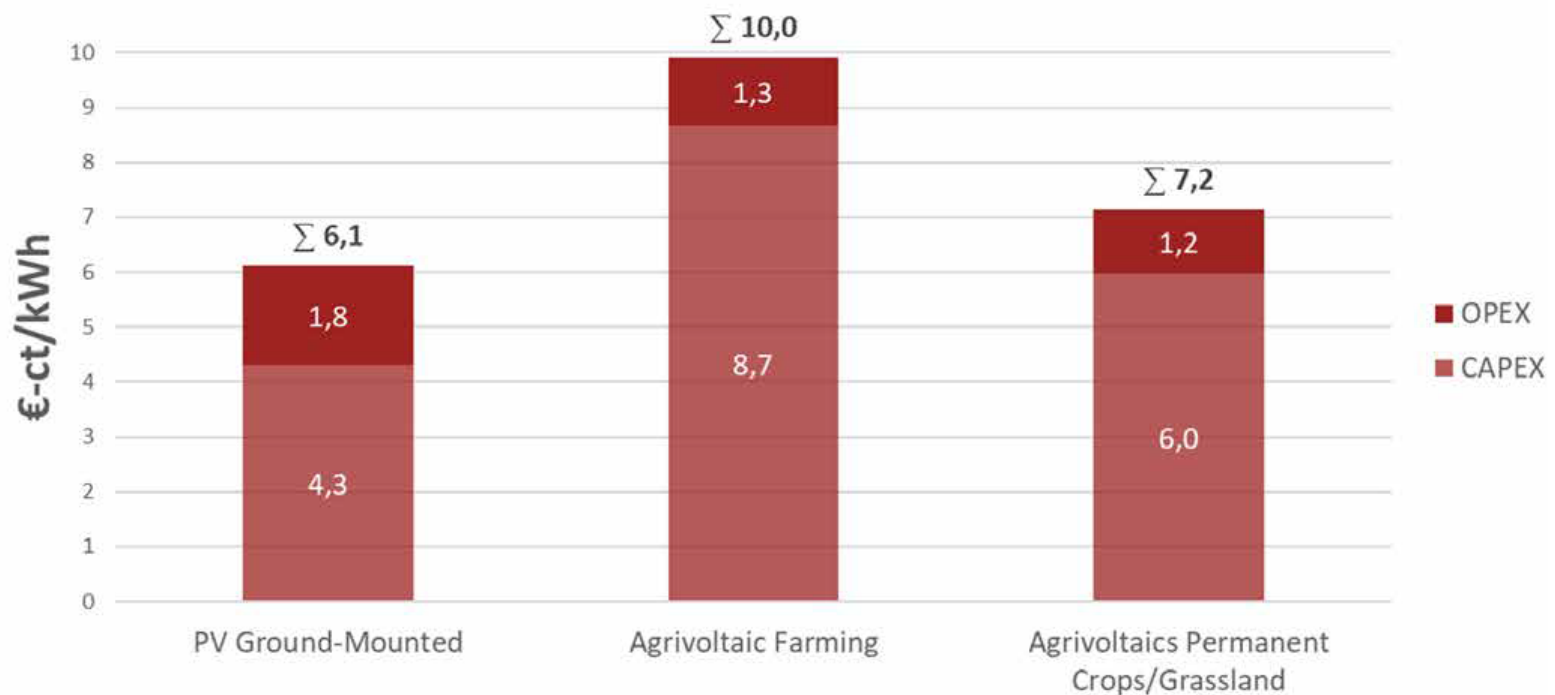

# Agriphotovoltaics

What are the suitable crops?

**All** plants, but specially...

**shade tolerant crops** such as leafy vegetables (lettuce), field forage (grass/clover mixture), pomaceous and stone fruits, berries, soft fruits, and other special crops (such as wild garlic, asparagus, and hops).

And **sensitive crops** (agriPV offers protection) wine growing, orchards, and vegetable cultivation

# Agriphotovoltaics

## Impact on soil

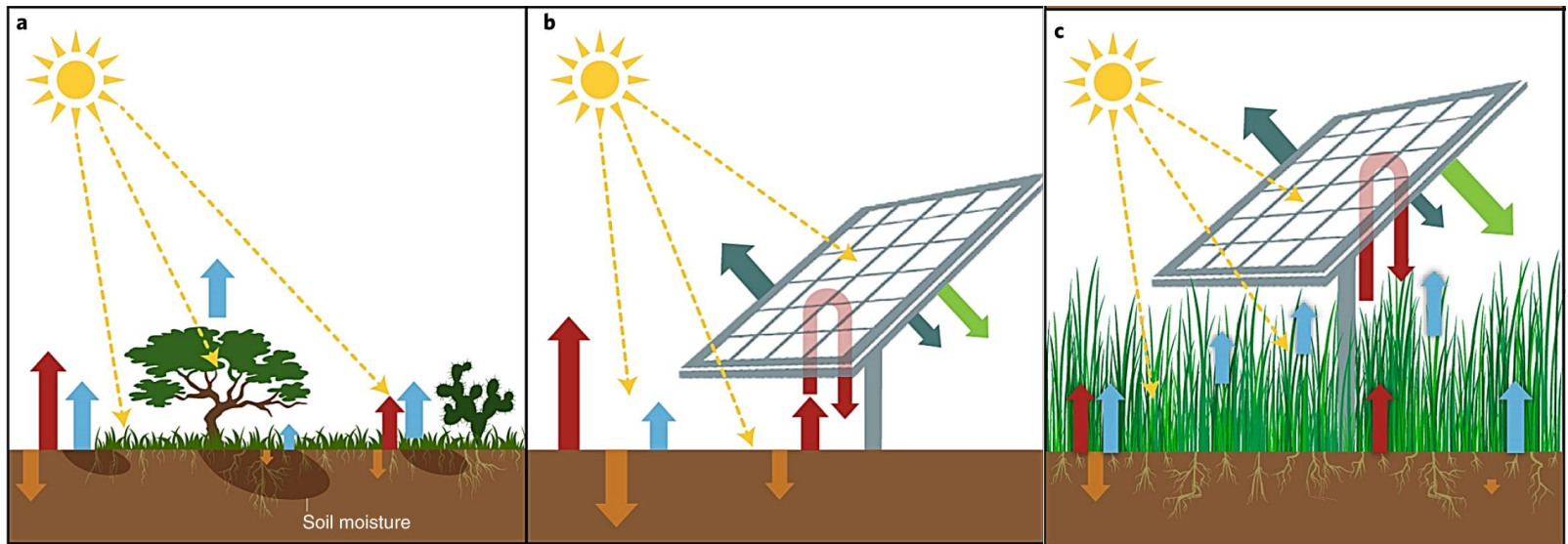

No vegetation reduces **latent heat** fluxes yielding higher temperature and sensible **heat fluxes**

# Agriphotovoltaics

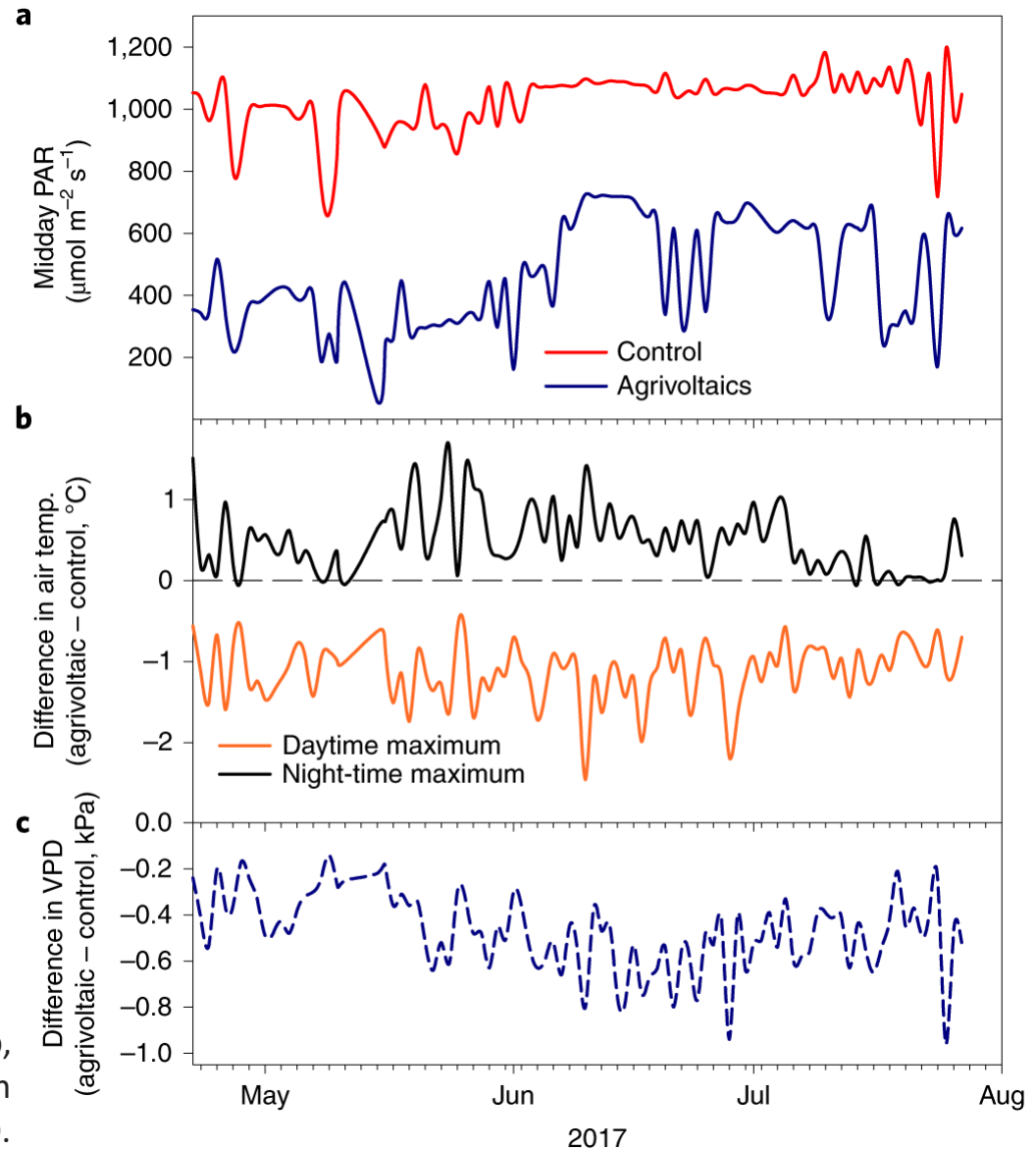

**a**, Average daily light levels in terms of PAR. **b**,

Differences in ambient air temperature between

daytime and night-time. **c**, Atmospheric dryness, VPD.

# Agriphotovoltaics

## Impact on soil & crop yield

- Reduced evaporation due to shading  
(and thus lower irrigation needs ~20%)
- Protection against intense solar radiation
- Reduced wind erosion
- Rainwater collection for irrigation



# Agriphotovoltaics

## Light management

Irradiation needs depend on crop

Homogeneous light is desirable for healthy plant growth and uniform ripening



- Use narrower PV modules
- East-west alignment
- Height = 1.5x PV row

# Agriphotovoltaics

## Challenges (besides cost)

- Design according to local conditions
- Soil compaction during the construction of the system
- Damage to the plants under the eaves of the modules



Chinese cabbage showed yield reductions due to shading between 29 and 50 percent.

# Agriphotovoltaics

## Technical Data of the System:

Area:	21 x 23 m = 483 m <sup>2</sup>
Moverdesk:	3 pieces per 3,2 x 21 m per 30 modules per 1,6 m <sup>2</sup>
Tracking:	east-west, calendar controlled
PV module:	CSG 245 W <sub>p</sub> ; 200 W <sub>p</sub> /m <sup>2</sup> (average value); 245 W <sub>p</sub> x 90 = 22 kW <sub>p</sub> ; 45 W <sub>p</sub> /m <sup>2</sup>
Production/a:	about 35.000 kWh
Use:	own consumption, no subsidy

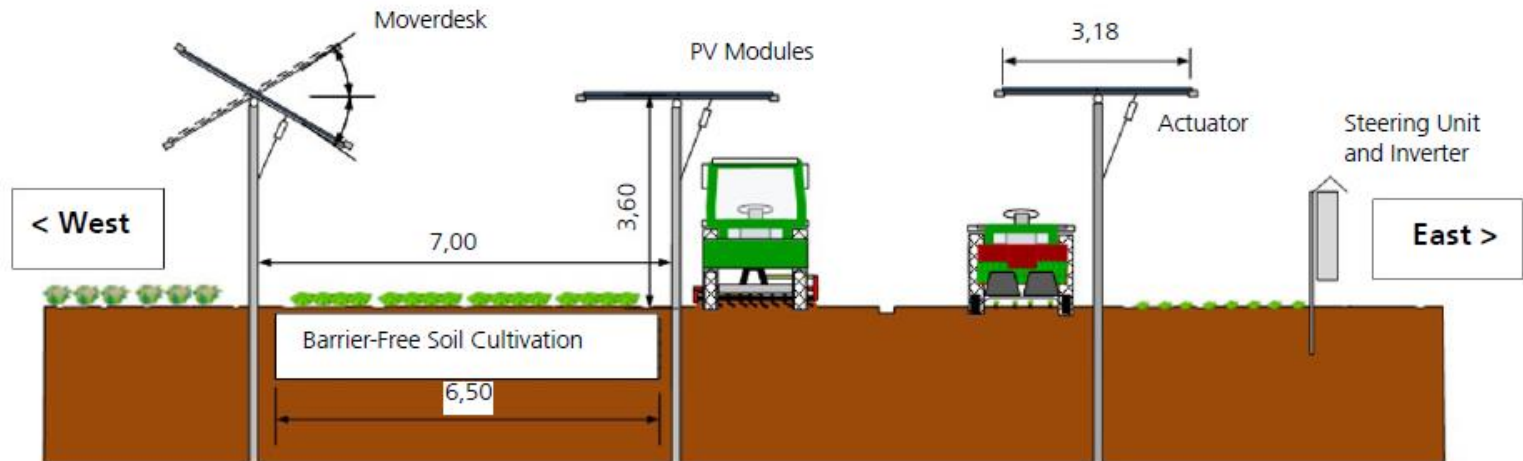

Figure 9: Cross-section of the agrivoltaic plant in Weißenstephan. © 2020 B. Ehrmaier, M. Beck, U. Bodmer



























Semi-shade by tubular PV modules, installed between tension cables by the company TubeSolar





System with high mounting structure and narrow PV modules.



System with high mounting structure and continuous rows of PV modules.



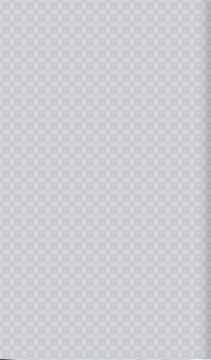

















Agriphotovoltaics has a great potential at all latitudes. It reduces impacts of large power plants, provides new income to farmers, if properly managed, increases crop yield and reduces irrigation needs.

But it is more expensive and requires local O&M expertise (good for new jobs!)